

# Spandex Modular Sign Systems

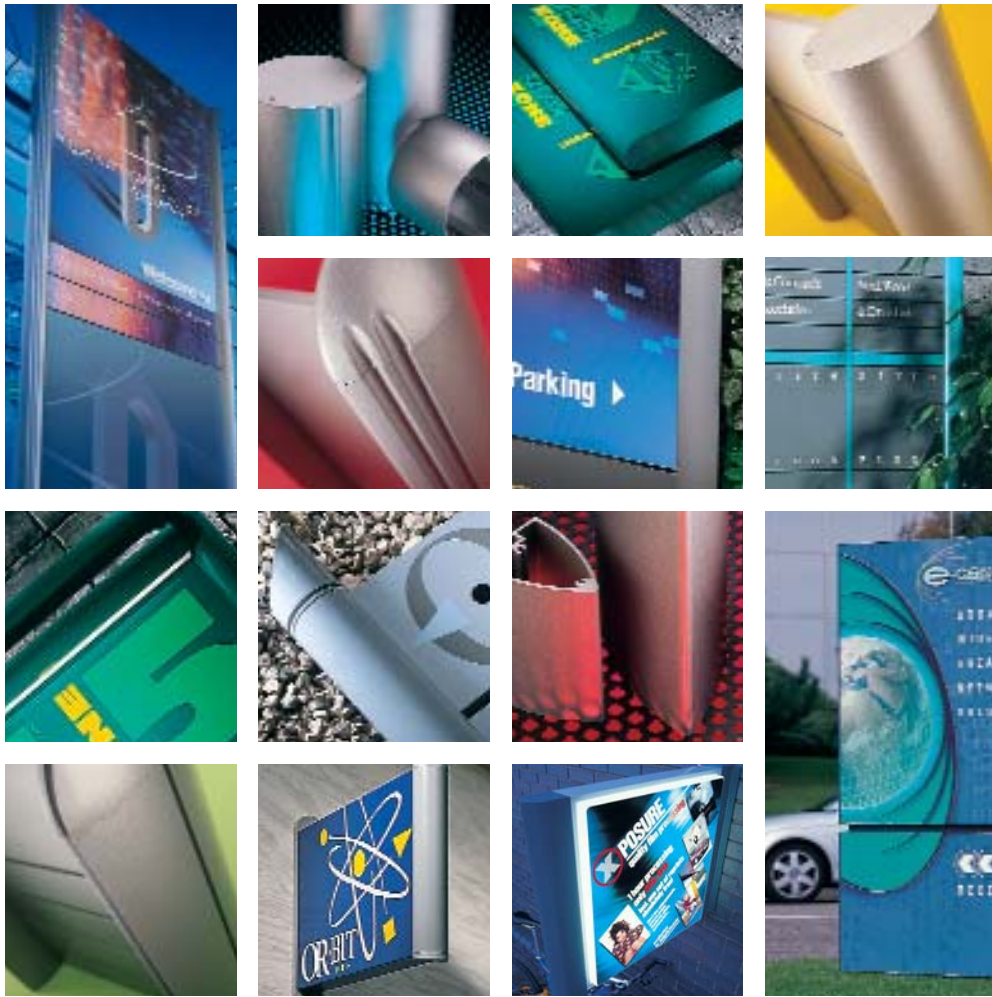

## Sign decisions made simple

S i m p l e   t o   d e s i g n



S i m p l e   t o   s p e c i f y



S i m p l y   S p a n d e x



Your partner in sign systems

## Setting the standard



Spandex sign systems have set the industry standard worldwide since 1976. On their own or as part of a co-ordinating programme of signs, our systems offer unlimited design opportunities. You can confidently specify Spandex sign systems, secure in the knowledge that the sign system you've chosen has its future guaranteed by the world's largest sign supplies company.

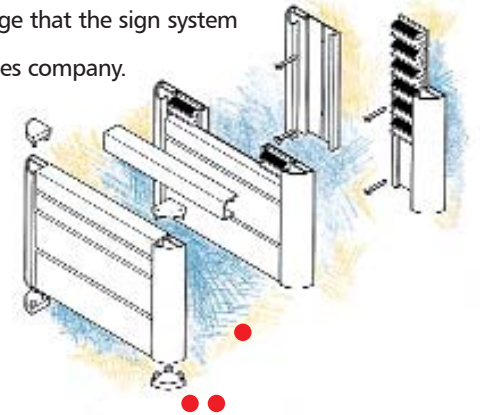

## Versatile signs

It could be a hotel or an office complex; a shopping centre or a business park. Wherever there's a building to identify; a message to communicate; or people to direct; you'll find a Spandex sign system.... or the need for one. Spandex is responsible for the design and distribution of the industry's most successful and comprehensive range of aluminium sign systems.

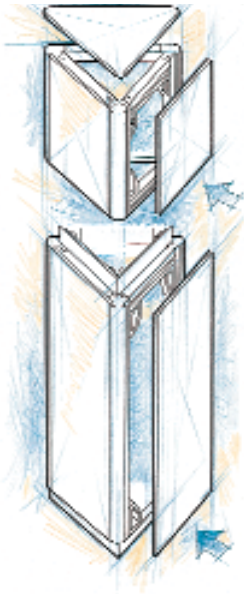

## Innovative designs



If you think that working with sign systems might be too restricting - think again. We've designed our sign system components to be as versatile as you need them to be. So, the signs you design or specify can be as individual as you want them to be. No two signs need ever look the same. Unless, of course, you decide they should.

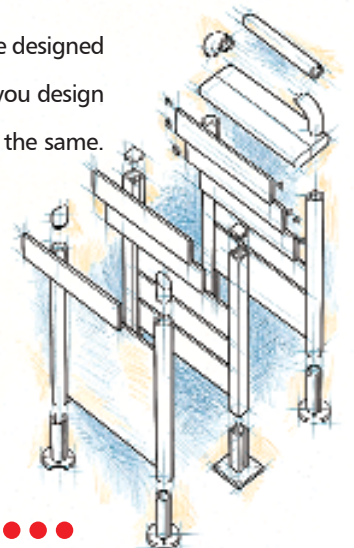

## Choosing the System



To find out what it is that makes Spandex sign systems so popular with architects, designers and signmakers alike, please spend a few moments looking at our sign systems individually. It won't take you long to realise that there are literally hundreds of good reasons why you should be working with Spandex sign systems too.

# C-Fix

## Directional Sign System



Directional signs.

Information points.

Advertising opportunities

**The C-Fix system is a refreshingly modern approach to 'fingerpost' signs.**

**This attractive modular sign system has been designed to meet the demand for an alternative to the overworked 'Victoriana' style.**

Exterior or interior locations; on its own or as part of a programme of signs; the C-Fix system can be used to direct, identify or inform. C-Fix signs can be finished with our Signpole 80 caps or the attractive C-Fix Dome Cap. Alternatively, you might like to top your sign off with a round or rectangular Crown Panel. The optional Crown Panel components are perfect for displaying additional information or advertising. C-Fix. Its versatility will appeal to you. Its profile will appeal to everyone.

# Spandex Modular Sign Systems

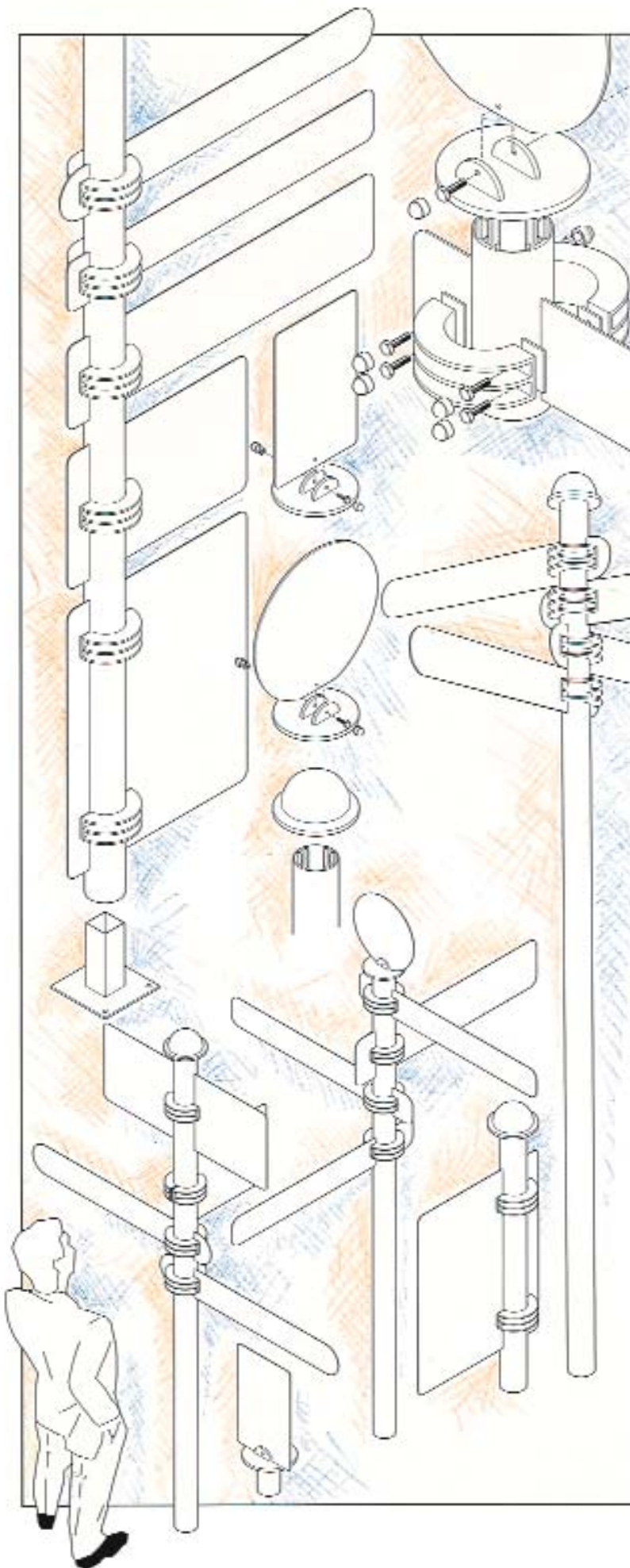

**AUSTRIA**  
**Spandex GmbH**  
 Tel 00 43 1769 3950  
 Fax 00 43 1769 3966

**BELGIUM**  
**Spandex Benelux NV SA**  
 Tel 00 32 2725 7370  
 Fax 00 32 2720 7640

**CANADA**  
**ND Graphic Products Ltd**  
 Tel 001 416 663 6416  
 Fax 001 416 663 5629

**CZECH REPUBLIC**  
**Spandex Syndicut Sro**  
 Tel 00 420 286 006455  
 Fax 00 420 286 006400

**FRANCE**  
**Spandex France SA**  
 Tel 00 33 169 352 450  
 Fax 00 33 169 352 499

**GERMANY**  
**H. Brunner GmbH**  
 Tel 00 49 7841 685 200  
 Fax 00 49 7841 685 100

**HOLLAND**  
**Spandex Benelux BV**  
 Tel 00 31 318 530 111  
 Fax 00 31 318 527 960

**ITALY**  
**Spandex Srl**  
 Tel 00 39 0332 420 611  
 Fax 00 39 0332 420 620

**SLOVAKIA**  
**Spandex Unifol Sro**  
 Tel 00 4212 5720 5555  
 Fax 00 4212 5720 5500

**SPAIN**  
**Spandex Espana SA**  
 Tel 00 34 93 656 9040  
 Fax 00 34 93 656 9041

**SVERIGE**  
**R&D Sverige AB**  
 Tel 00 46 430 738 29  
 Fax 00 46 430 133 17

**SWITZERLAND**  
**Spandex AG**  
 Tel 00 41 1818 8686  
 Fax 00 41 1818 8688

**UNITED KINGDOM**  
**Spandex Ltd**  
 Tel 00 44 1454 616444  
 Fax 00 44 1454 616777

**Distributed By:**



# Infopanel

## Exterior Directory System



Robust directories

Information signs

Integrated downlighters

Easily customised



**Infopanel is the key to great looking exterior directories.**

**It's as versatile as you need it to be.**

The system's robust, extruded aluminium posts, poles and panels combine to provide exterior directory signs with real presence. Free-standing or wall-mounted, any number of "looks" can be achieved using Infopanel decorative post caps and corner components. You can even illuminate your exterior directories with Infopanel Luminaire. Infopanel Edge and Brace components allow custom panels of any size to be used, adding even greater impact to your exterior signs.

# Spandex Modular Sign Systems

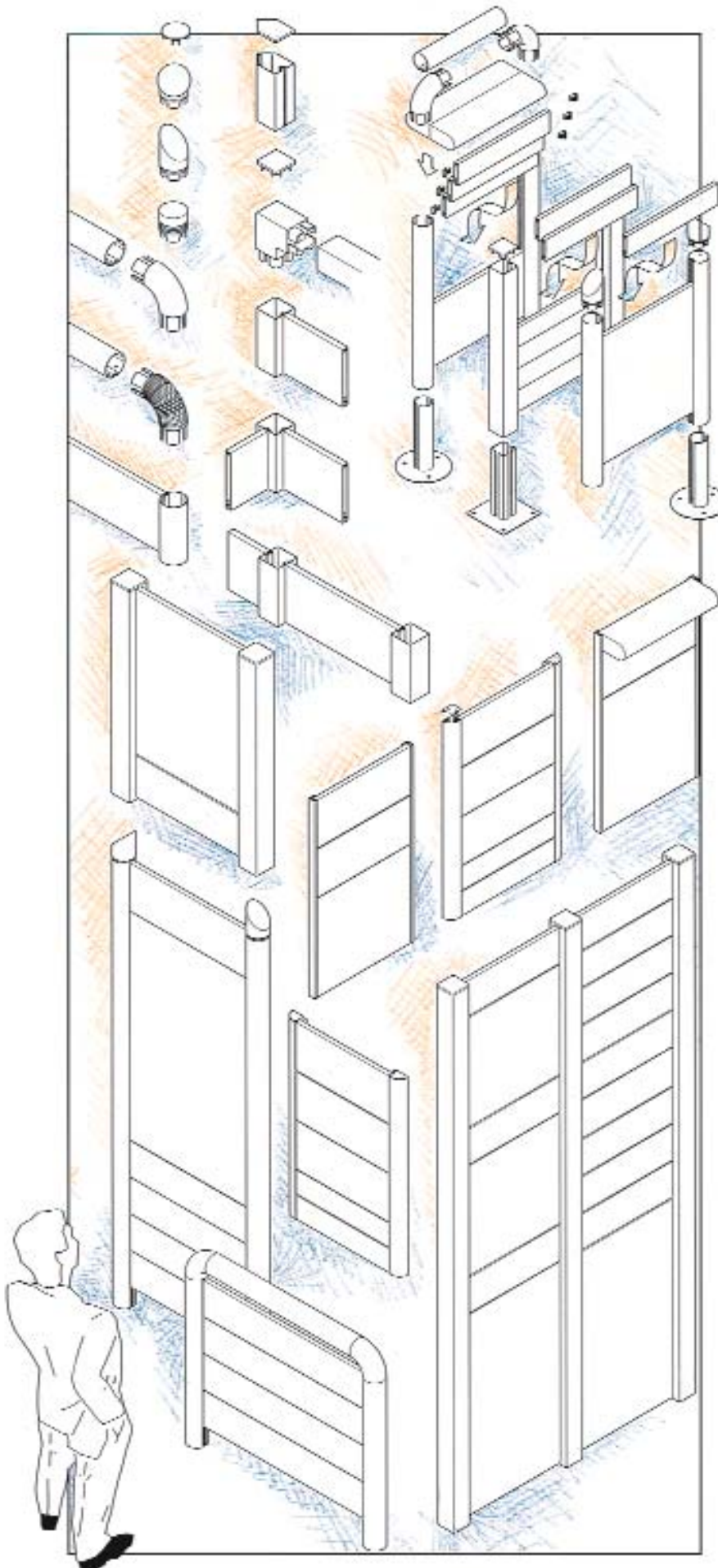

**AUSTRIA**

**Spandex GmbH**  
 Tel 00 43 1769 3950  
 Fax 00 43 1769 3966

**BELGIUM**

**Spandex Benelux NV SA**  
 Tel 00 32 2725 7370  
 Fax 00 32 2720 7640

**CANADA**

**ND Graphic Products Ltd**  
 Tel 001 416 663 6416  
 Fax 001 416 663 5629

**CZECH REPUBLIC**

**Spandex Syndicut Sro**  
 Tel 00 420 286 006455  
 Fax 00 420 286 006400

**FRANCE**

**Spandex France SA**  
 Tel 00 33 169 352 450  
 Fax 00 33 169 352 499

**GERMANY**

**H. Brunner GmbH**  
 Tel 00 49 7841 685 200  
 Fax 00 49 7841 685 100

**HOLLAND**

**Spandex Benelux BV**  
 Tel 00 31 318 530 111  
 Fax 00 31 318 527 960

**ITALY**

**Spandex Srl**  
 Tel 00 39 0332 420 611  
 Fax 00 39 0332 420 620

**SLOVAKIA**

**Spandex Unifol Sro**  
 Tel 00 4212 5720 5555  
 Fax 00 4212 5720 5500

**SPAIN**

**Spandex Espana SA**  
 Tel 00 34 93 656 9040  
 Fax 00 34 93 656 9041

**SVERIGE**

**R&D Sverige AB**  
 Tel 00 46 430 738 29  
 Fax 00 46 430 133 17

**SWITZERLAND**

**Spandex AG**  
 Tel 00 41 1818 8686  
 Fax 00 41 1818 8688

**UNITED KINGDOM**

**Spandex Ltd**  
 Tel 00 44 1454 616444  
 Fax 00 44 1454 616777

**Distributed By:**



# SlimSlatz

## Low Profile Interior Directory System



Elegant  
directories

Refined signs

Attractive  
profiles

Architectural  
appeal

### The SlimSlatz system combines versatility and elegance.

This refined sign system offers the same attractive user benefits as the original Slatz concept. Spandex designers have condensed the Slatz virtues of simplicity, versatility, and functionality into an assembled profile of less than 8mm - though nothing has been sacrificed in terms of appearance. Every SlimSlatz component has been designed with elegance in mind. Top and bottom faceplates fit flush to the mounting surface. This conceals the inner workings of the directory and provides a perfect finish to a perfect sign system.

SlimSlatz co-ordinates beautifully with every other system in the Spandex range. Which means that even the smallest interior sign can complement the largest exterior identity programme.



# Spandex Modular Sign Systems

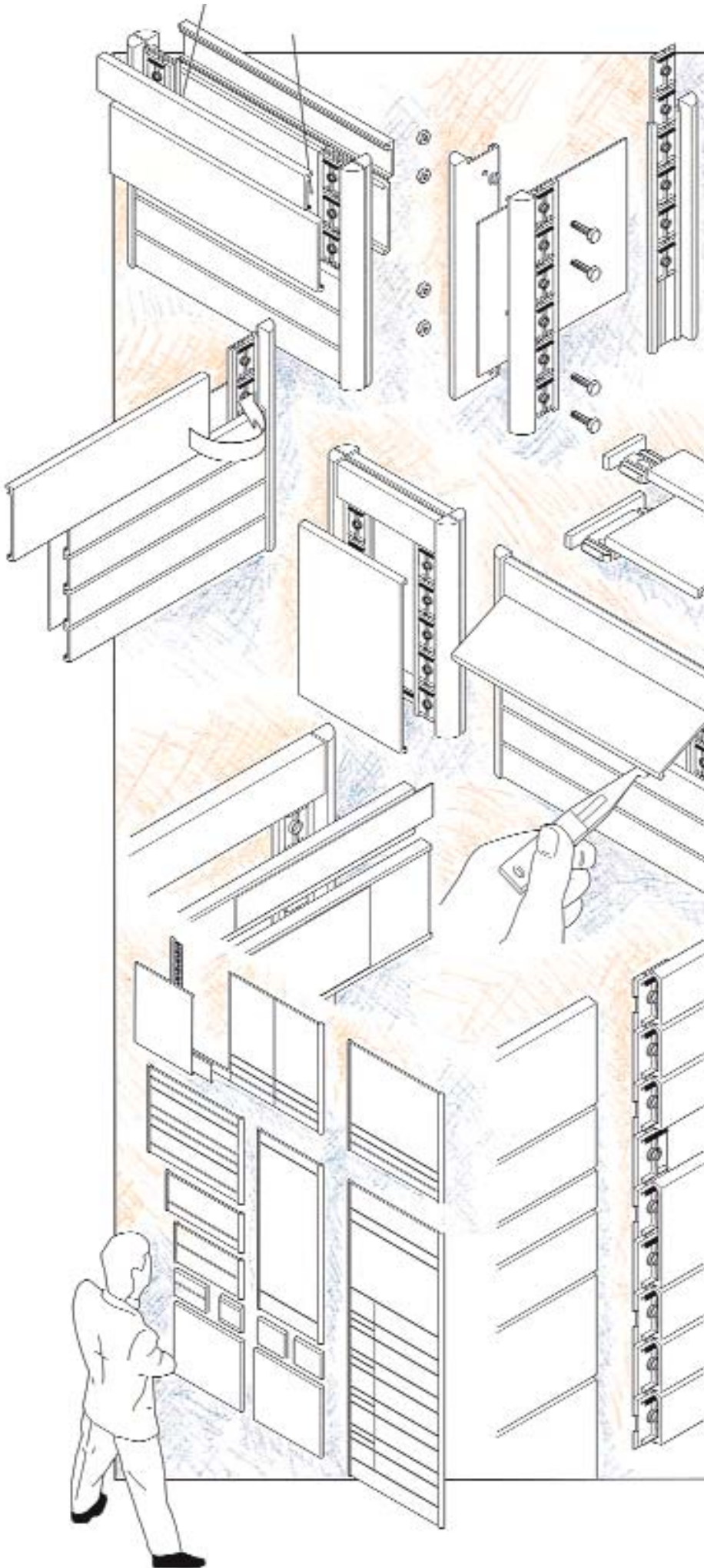

**AUSTRIA**

**Spandex GmbH**  
 Tel 00 43 1769 3950  
 Fax 00 43 1769 3966

**BELGIUM**

**Spandex Benelux NV SA**  
 Tel 00 32 2725 7370  
 Fax 00 32 2720 7640

**CANADA**

**ND Graphic Products Ltd**  
 Tel 001 416 663 6416  
 Fax 001 416 663 5629

**CZECH REPUBLIC**

**Spandex Syndicut Sro**  
 Tel 00 420 286 006455  
 Fax 00 420 286 006400

**FRANCE**

**Spandex France SA**  
 Tel 00 33 169 352 450  
 Fax 00 33 169 352 499

**GERMANY**

**H. Brunner GmbH**  
 Tel 00 49 7841 685 200  
 Fax 00 49 7841 685 100

**HOLLAND**

**Spandex Benelux BV**  
 Tel 00 31 318 530 111  
 Fax 00 31 318 527 960

**ITALY**

**Spandex Srl**  
 Tel 00 39 0332 420 611  
 Fax 00 39 0332 420 620

**SLOVAKIA**

**Spandex Unifol Sro**  
 Tel 00 4212 5720 5555  
 Fax 00 4212 5720 5500

**SPAIN**

**Spandex Espana SA**  
 Tel 00 34 93 656 9040  
 Fax 00 34 93 656 9041

**SVERIGE**

**R&D Sverige AB**  
 Tel 00 46 430 738 29  
 Fax 00 46 430 133 17

**SWITZERLAND**

**Spandex AG**  
 Tel 00 41 1818 8686  
 Fax 00 41 1818 8688

**UNITED KINGDOM**

**Spandex Ltd**  
 Tel 00 44 1454 616444  
 Fax 00 44 1454 616777

**Distributed By:**





# Monoframe

## Exterior Identity System



Corporate identity signs

Business park systems



**Monoframe is the most direct route to attractive, post or base-mounted identity signs. Monoframe will make sure your message gets noticed.**

Whether you opt for the slim Monoframe 55, or the imposing Monoframe 175; working with this time with anything else? Monoframe exterior identity signs are absolutely ideal for business or science park locations and similar corporate facilities.

# Spandex Modular Sign Systems

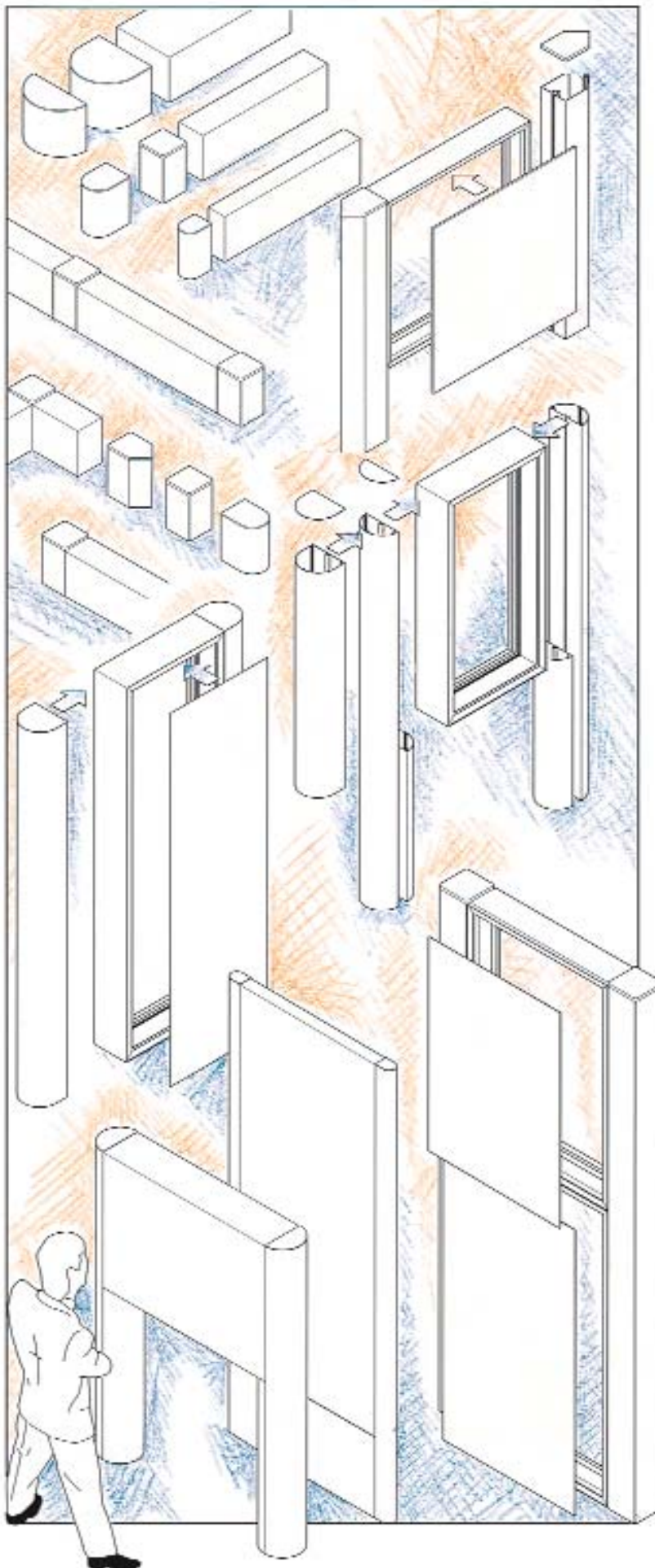

**AUSTRIA**

**Spandex GmbH**  
 Tel 00 43 1769 3950  
 Fax 00 43 1769 3966

**BELGIUM**

**Spandex Benelux NV SA**  
 Tel 00 32 2725 7370  
 Fax 00 32 2720 7640

**CANADA**

**ND Graphic Products Ltd**  
 Tel 001 416 663 6416  
 Fax 001 416 663 5629

**CZECH REPUBLIC**

**Spandex Syndicut Sro**  
 Tel 00 420 286 006455  
 Fax 00 420 286 006400

**FRANCE**

**Spandex France SA**  
 Tel 00 33 169 352 450  
 Fax 00 33 169 352 499

**GERMANY**

**H. Brunner GmbH**  
 Tel 00 49 7841 685 200  
 Fax 00 49 7841 685 100

**HOLLAND**

**Spandex Benelux BV**  
 Tel 00 31 318 530 111  
 Fax 00 31 318 527 960

**ITALY**

**Spandex Srl**  
 Tel 00 39 0332 420 611  
 Fax 00 39 0332 420 620

**SLOVAKIA**

**Spandex Unifol Sro**  
 Tel 00 4212 5720 5555  
 Fax 00 4212 5720 5500

**SPAIN**

**Spandex Espana SA**  
 Tel 00 34 93 656 9040  
 Fax 00 34 93 656 9041

**SVERIGE**

**R&D Sverige AB**  
 Tel 00 46 430 738 29  
 Fax 00 46 430 133 17

**SWITZERLAND**

**Spandex AG**  
 Tel 00 41 1818 8686  
 Fax 00 41 1818 8688

**UNITED KINGDOM**

**Spandex Ltd**  
 Tel 00 44 1454 616444  
 Fax 00 44 1454 616777

**Distributed By:**



# Sculptura

## Monolith Sign System



Free-standing  
directories

Corporate  
identity signs

Information  
systems



**Sculptura is the system  
to call for when a  
project cries out for  
something different.**

Create free-standing columns with  
radius, triangular  
or square profiles. Give  
your signs the size and  
proportions which will  
guarantee maximum  
visual impact.

Incorporate Slatz directories  
or design stencil cuts for  
flush-fitting sheet aluminium  
and back illumination.

The possibilities for  
Sculptura are endless.

# Spandex Modular Sign Systems

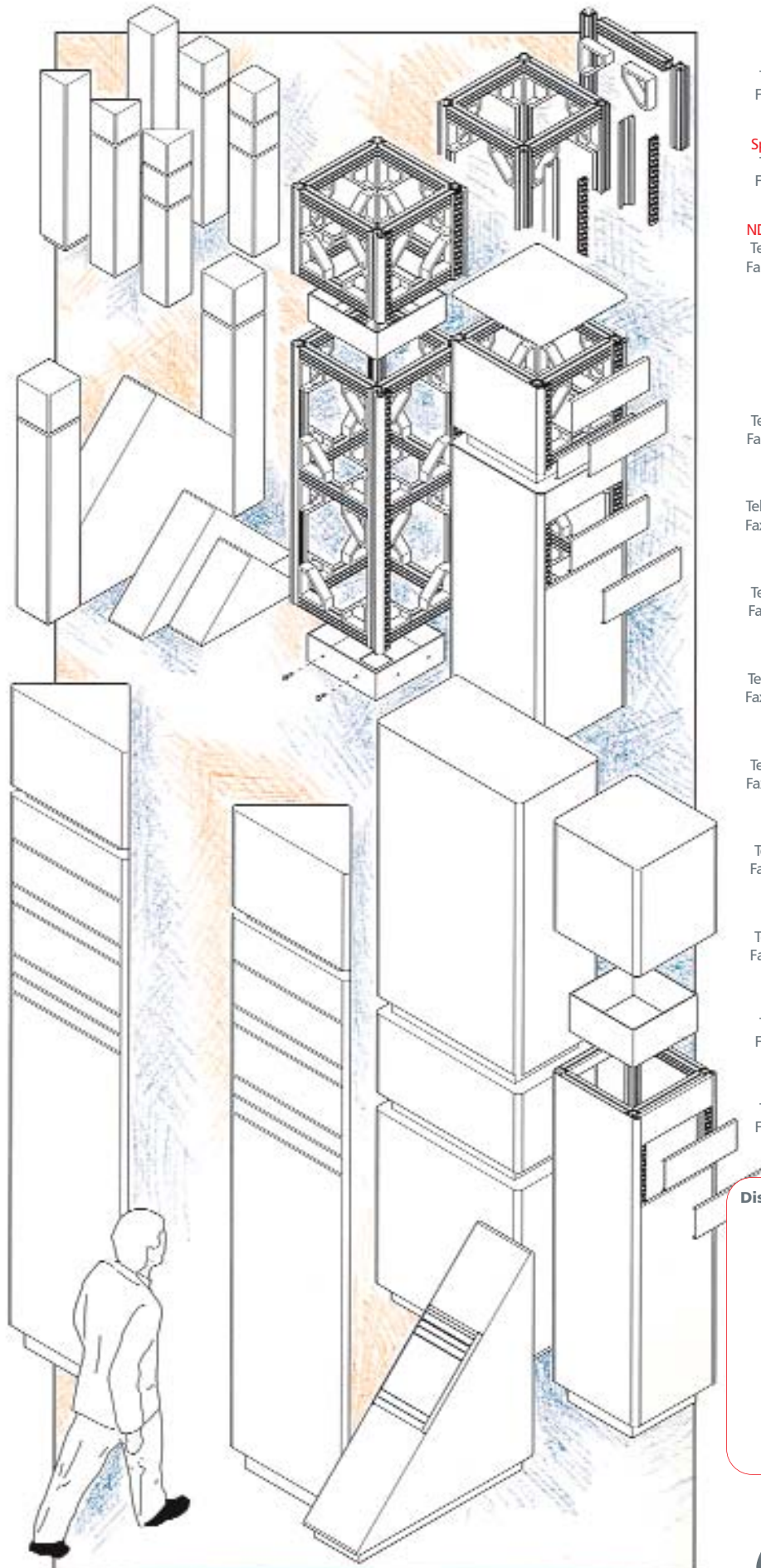

**AUSTRIA**  
**Spandex GmbH**  
 Tel 00 43 1769 3950  
 Fax 00 43 1769 3966

**BELGIUM**  
**Spandex Benelux NV SA**  
 Tel 00 32 2725 7370  
 Fax 00 32 2720 7640

**CANADA**  
**ND Graphic Products Ltd**  
 Tel 001 416 663 6416  
 Fax 001 416 663 5629

**CZECH REPUBLIC**  
**Spandex Syndicut Sro**  
 Tel 00 420 286 006455  
 Fax 00 420 286 006400

**FRANCE**  
**Spandex France SA**  
 Tel 00 33 169 352 450  
 Fax 00 33 169 352 499

**GERMANY**  
**H. Brunner GmbH**  
 Tel 00 49 7841 685 200  
 Fax 00 49 7841 685 100

**HOLLAND**  
**Spandex Benelux BV**  
 Tel 00 31 318 530 111  
 Fax 00 31 318 527 960

**ITALY**  
**Spandex Srl**  
 Tel 00 39 0332 420 611  
 Fax 00 39 0332 420 620

**SLOVAKIA**  
**Spandex Unifol Sro**  
 Tel 00 4212 5720 5555  
 Fax 00 4212 5720 5500

**SPAIN**  
**Spandex Espana SA**  
 Tel 00 34 93 656 9040  
 Fax 00 34 93 656 9041

**SVERIGE**  
**R&D Sverige AB**  
 Tel 00 46 430 738 29  
 Fax 00 46 430 133 17

**SWITZERLAND**  
**Spandex AG**  
 Tel 00 41 1818 8686  
 Fax 00 41 1818 8688

**UNITED KINGDOM**  
**Spandex Ltd**  
 Tel 00 44 1454 616444  
 Fax 00 44 1454 616777

**Distributed By:**



# Klick Rail

Flexible Face Signbox / Trim System



Large fascia signs

Forecourt canopies

Illuminated or non-illuminated

Single or double-sided



**Klick Rail is the professional approach to big signs. Illuminated or non-illuminated, Klick Rail gives you biggest and brightest single or double-sided signs.**

The Klick Rail framework utilises flexible face materials. Its highly effective tensioning system takes all the strain out of even the largest signs.

So you can have the freedom to create fascia signs of virtually any size with Klick Rail. And it lets you take signs around corners seamlessly. Perfect for projects like filling station canopies.

# Spandex Modular Sign Systems

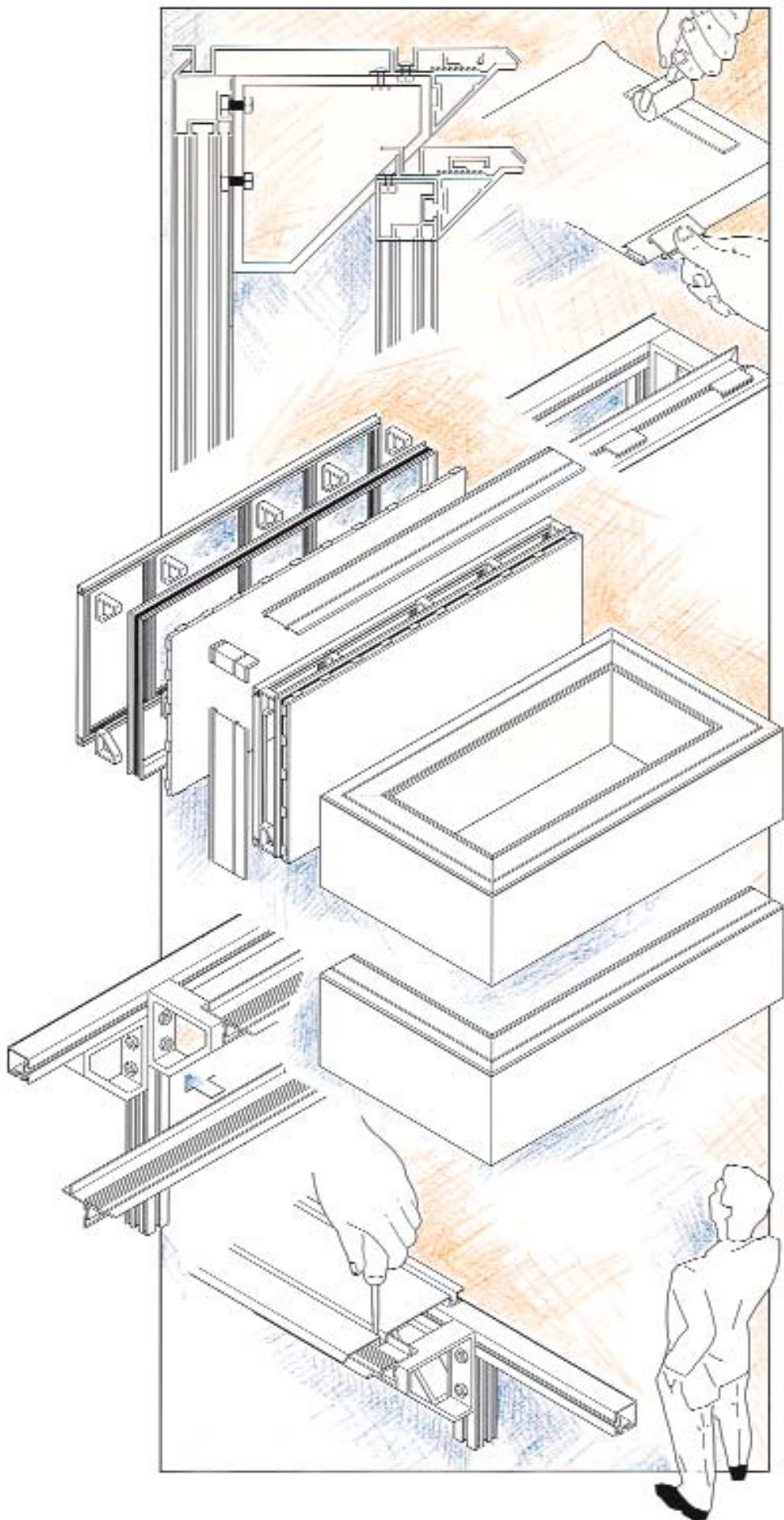

**AUSTRIA**

**Spandex GmbH**  
 Tel 00 43 1769 3950  
 Fax 00 43 1769 3966

**BELGIUM**

**Spandex Benelux NV SA**  
 Tel 00 32 2725 7370  
 Fax 00 32 2720 7640

**CANADA**

**ND Graphic Products Ltd**  
 Tel 001 416 663 6416  
 Fax 001 416 663 5629

**CZECH REPUBLIC**

**Spandex Syndicut Sro**  
 Tel 00 420 286 006455  
 Fax 00 420 286 006400

**FRANCE**

**Spandex France SA**  
 Tel 00 33 169 352 450  
 Fax 00 33 169 352 499

**GERMANY**

**H. Brunner GmbH**  
 Tel 00 49 7841 685 200  
 Fax 00 49 7841 685 100

**HOLLAND**

**Spandex Benelux BV**  
 Tel 00 31 318 530 111  
 Fax 00 31 318 527 960

**ITALY**

**Spandex Srl**  
 Tel 00 39 0332 420 611  
 Fax 00 39 0332 420 620

**SLOVAKIA**

**Spandex Unifol Sro**  
 Tel 00 4212 5720 5555  
 Fax 00 4212 5720 5500

**SPAIN**

**Spandex Espana SA**  
 Tel 00 34 93 656 9040  
 Fax 00 34 93 656 9041

**SVERIGE**

**R&D Sverige AB**  
 Tel 00 46 430 738 29  
 Fax 00 46 430 133 17

**SWITZERLAND**

**Spandex AG**  
 Tel 00 41 1818 8686  
 Fax 00 41 1818 8688

**UNITED KINGDOM**

**Spandex Ltd**  
 Tel 00 44 1454 616444  
 Fax 00 44 1454 616777

**Distributed By:**



# Festival & Bannertrack

## Flexible & Rigid Banner Support Systems

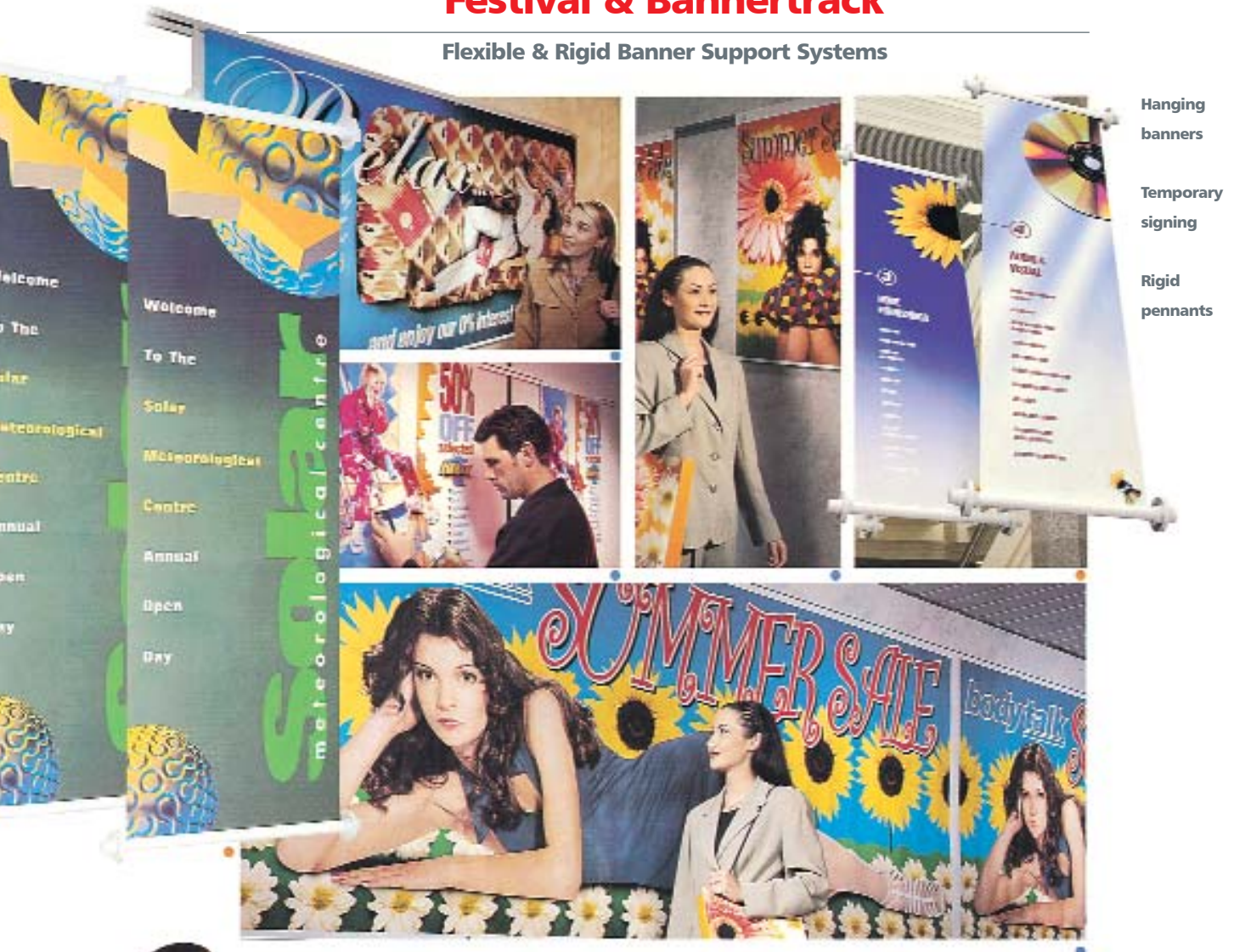

Hanging banners

Temporary signing

Rigid pennants



- **Festival banner poles turn the humble banner into a refined architectural feature.**

From shopping malls to exhibition halls; Festival can be seen supporting banners and attracting attention. Based on our successful Signpole 20 and 40 aluminium extrusions, Festival uses the minimum of components to maximum effect. Hanging or projecting; with plain or decorative moulded end caps;

Festival is easy to use and can co-ordinate beautifully with other Spandex sign systems.

- **BannerTrack is new, permanent solution to displaying temporary signs. From promotional banners to poster-sized prints.**

With its patented 'twist and fix' fasteners and unobtrusive aluminium profile, BannerTrack solves the problem of drooping banners once and for all. Banners and signs of virtually any length can be installed, removed or repositioned effortlessly. BannerTrack can be recessed or taken around corners and looks great as a contrasting décor line or custom finished to match an existing colour scheme.

# Spandex Modular Sign Systems

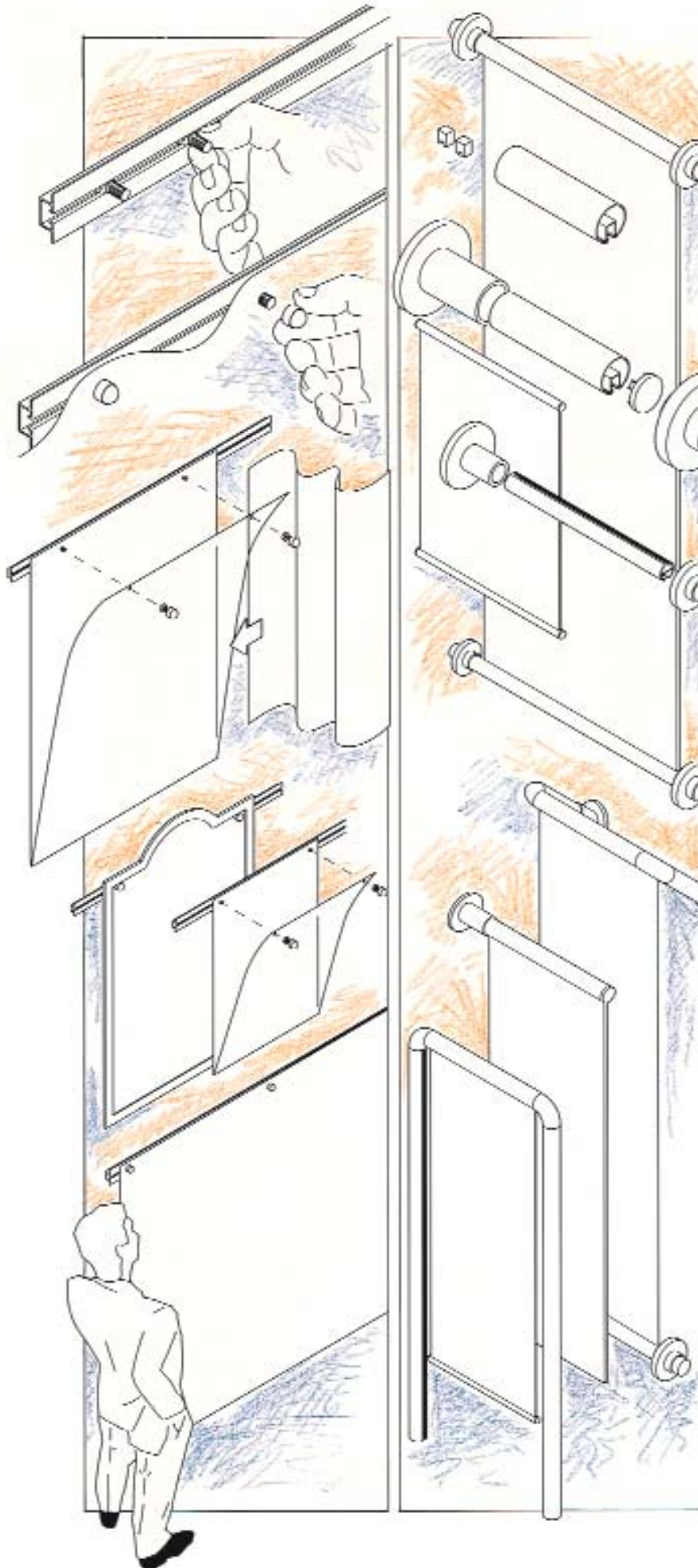

**AUSTRIA**  
**Spandex GmbH**  
 Tel 00 43 1769 3950  
 Fax 00 43 1769 3966

**BELGIUM**  
**Spandex Benelux NV SA**  
 Tel 00 32 2725 7370  
 Fax 00 32 2720 7640

**CANADA**  
**ND Graphic Products Ltd**  
 Tel 001 416 663 6416  
 Fax 001 416 663 5629

**CZECH REPUBLIC**  
**Spandex Syndicut Sro**  
 Tel 00 420 286 006455  
 Fax 00 420 286 006400

**FRANCE**  
**Spandex France SA**  
 Tel 00 33 169 352 450  
 Fax 00 33 169 352 499

**GERMANY**  
**H. Brunner GmbH**  
 Tel 00 49 7841 685 200  
 Fax 00 49 7841 685 100

**HOLLAND**  
**Spandex Benelux BV**  
 Tel 00 31 318 530 111  
 Fax 00 31 318 527 960

**ITALY**  
**Spandex Srl**  
 Tel 00 39 0332 420 611  
 Fax 00 39 0332 420 620

**SLOVAKIA**  
**Spandex Unifol Sro**  
 Tel 00 4212 5720 5555  
 Fax 00 4212 5720 5500

**SPAIN**  
**Spandex Espana SA**  
 Tel 00 34 93 656 9040  
 Fax 00 34 93 656 9041

**SVERIGE**  
**R&D Sverige AB**  
 Tel 00 46 430 738 29  
 Fax 00 46 430 133 17

**SWITZERLAND**  
**Spandex AG**  
 Tel 00 41 1818 8686  
 Fax 00 41 1818 8688

**UNITED KINGDOM**  
**Spandex Ltd**  
 Tel 00 44 1454 616444  
 Fax 00 44 1454 616777

**Distributed By:**





# Slatz

## Interior Directory System



Wall-mounted directories

Suspended directories

Projecting signs

Desktop signs

**The Slatz directory system is nothing short of a design classic. So simple, yet so versatile.**

Slatz directories can be installed just about anywhere. Alcoves and inconvenient architecture are no problem for the unique face-fitting components of the Slatz sign system. Slatz directories can even be recessed. Slatz components can be used to create everything from a single desktop sign to an entire programme of co-ordinating interior directories. Wall-mounted or free-standing; projecting or suspended; single or double-sided; the Slatz directory system does it all. Which is why Slatz is the preferred choice of architects, designers and signmakers worldwide.

# Spandex Modular Sign Systems

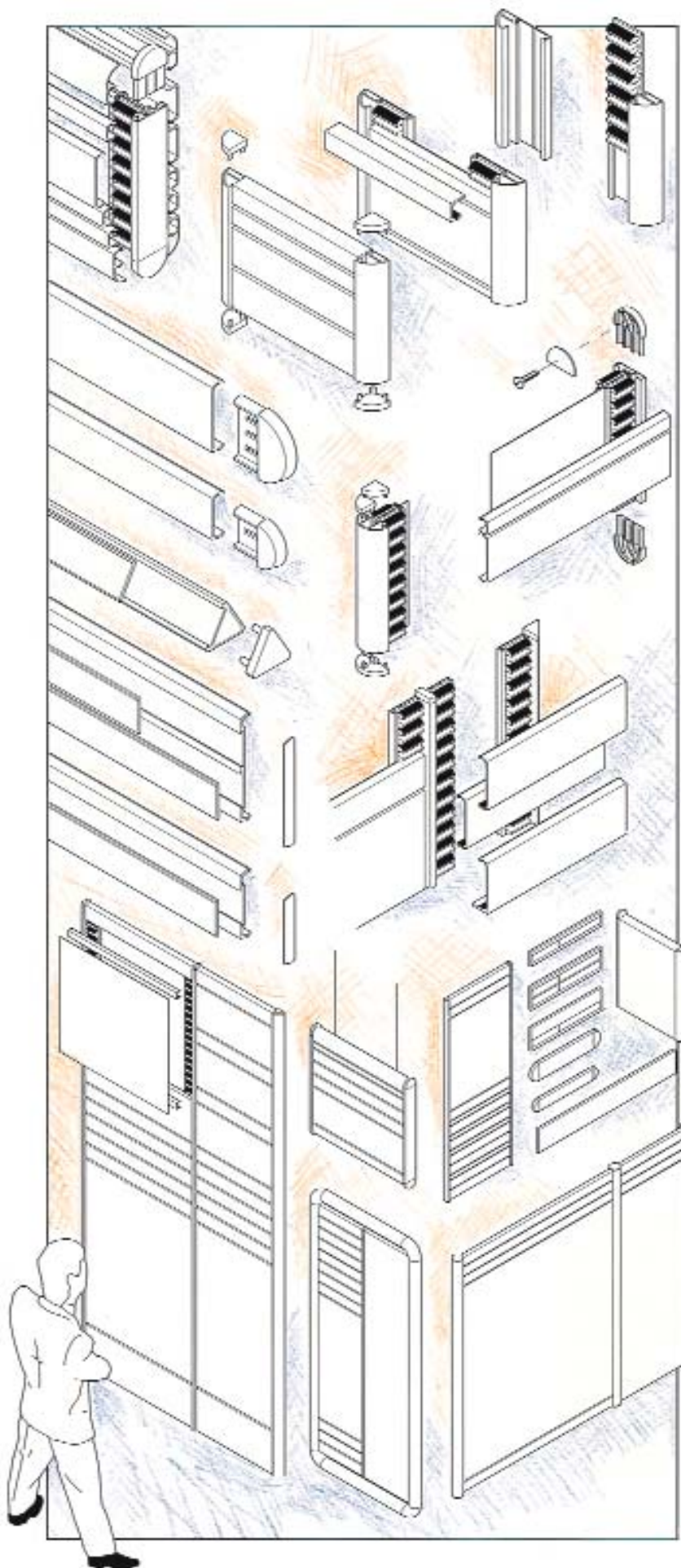

**AUSTRIA**

**Spandex GmbH**  
 Tel 00 43 1769 3950  
 Fax 00 43 1769 3966

**BELGIUM**

**Spandex Benelux NV SA**  
 Tel 00 32 2725 7370  
 Fax 00 32 2720 7640

**CANADA**

**ND Graphic Products Ltd**  
 Tel 001 416 663 6416  
 Fax 001 416 663 5629

**CZECH REPUBLIC**

**Spandex Syndicut Sro**  
 Tel 00 420 286 006455  
 Fax 00 420 286 006400

**FRANCE**

**Spandex France SA**  
 Tel 00 33 169 352 450  
 Fax 00 33 169 352 499

**GERMANY**

**H. Brunner GmbH**  
 Tel 00 49 7841 685 200  
 Fax 00 49 7841 685 100

**HOLLAND**

**Spandex Benelux BV**  
 Tel 00 31 318 530 111  
 Fax 00 31 318 527 960

**ITALY**

**Spandex Srl**  
 Tel 00 39 0332 420 611  
 Fax 00 39 0332 420 620

**SLOVAKIA**

**Spandex Unifol Sro**  
 Tel 00 4212 5720 5555  
 Fax 00 4212 5720 5500

**SPAIN**

**Spandex Espana SA**  
 Tel 00 34 93 656 9040  
 Fax 00 34 93 656 9041

**SVERIGE**

**R&D Sverige AB**  
 Tel 00 46 430 738 29  
 Fax 00 46 430 133 17

**SWITZERLAND**

**Spandex AG**  
 Tel 00 41 1818 8686  
 Fax 00 41 1818 8688

**UNITED KINGDOM**

**Spandex Ltd**  
 Tel 00 44 1454 616444  
 Fax 00 44 1454 616777

**Distributed By:**



# Mainframe / Miniframe

## Rigid Face Signbox / Trim System

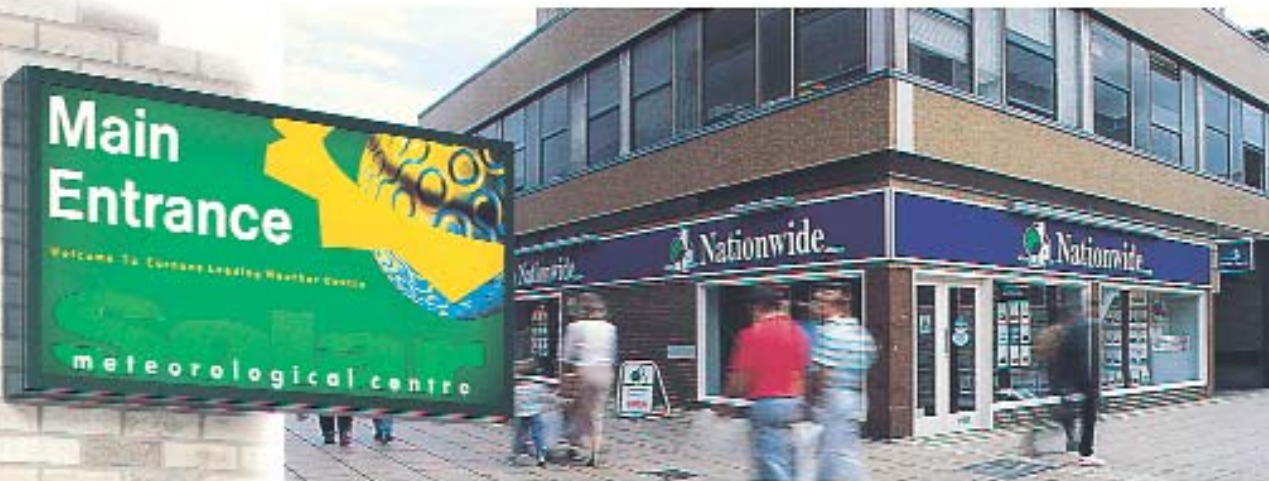

Illuminated  
signboxes

Functional sign  
frames

Single or  
double-sided

Wall-mounted  
or projecting



**The Mainframe signbox system makes the perfect fascia signbox. This versatile system accepts rigid acrylic face material from 3mm to 6mm, which can be stencil cut or decorated with translucent films.**

Mainframe's design allows easy access to electrical fittings for problem free maintenance.

Square section or curved edges; single or double-sided; wall-mounted or projecting; fixed direct or on stand-off brackets; the choice is yours with Mainframe. With its non-illuminated counterpart, Miniframe; you won't find a better way to produce illuminated signboxes or non-illuminated sign frames.

# Spandex Modular Sign Systems

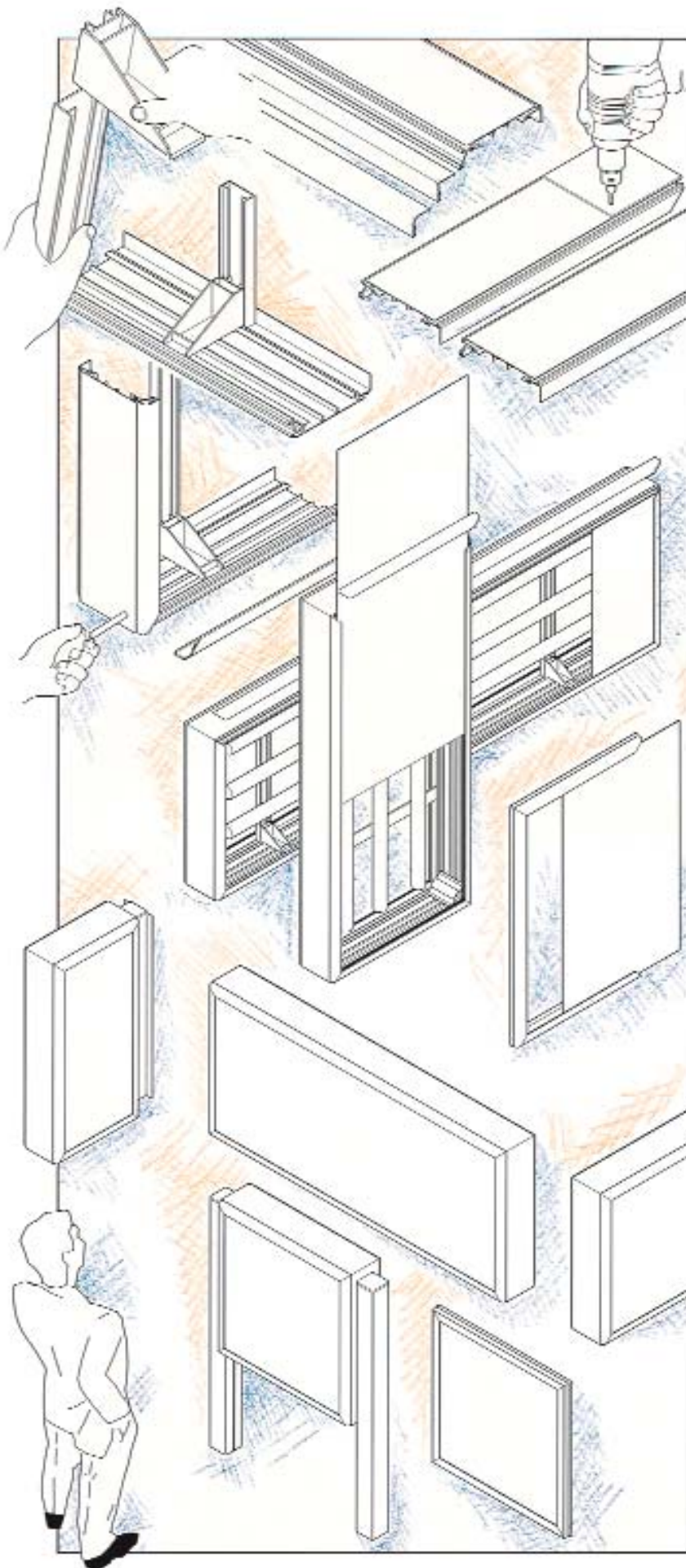

**AUSTRIA**  
**Spandex GmbH**  
 Tel 00 43 1769 3950  
 Fax 00 43 1769 3966

**BELGIUM**  
**Spandex Benelux NV SA**  
 Tel 00 32 2725 7370  
 Fax 00 32 2720 7640

**CANADA**  
**ND Graphic Products Ltd**  
 Tel 001 416 663 6416  
 Fax 001 416 663 5629

**CZECH REPUBLIC**  
**Spandex Syndicut Sro**  
 Tel 00 420 286 006455  
 Fax 00 420 286 006400

**FRANCE**  
**Spandex France SA**  
 Tel 00 33 169 352 450  
 Fax 00 33 169 352 499

**GERMANY**  
**H. Brunner GmbH**  
 Tel 00 49 7841 685 200  
 Fax 00 49 7841 685 100

**HOLLAND**  
**Spandex Benelux BV**  
 Tel 00 31 318 530 111  
 Fax 00 31 318 527 960

**ITALY**  
**Spandex Srl**  
 Tel 00 39 0332 420 611  
 Fax 00 39 0332 420 620

**SLOVAKIA**  
**Spandex Unifol Sro**  
 Tel 00 4212 5720 5555  
 Fax 00 4212 5720 5500

**SPAIN**  
**Spandex Espana SA**  
 Tel 00 34 93 656 9040  
 Fax 00 34 93 656 9041

**SVERIGE**  
**R&D Sverige AB**  
 Tel 00 46 430 738 29  
 Fax 00 46 430 133 17

**SWITZERLAND**  
**Spandex AG**  
 Tel 00 41 1818 8686  
 Fax 00 41 1818 8688

**UNITED KINGDOM**  
**Spandex Ltd**  
 Tel 00 44 1454 616444  
 Fax 00 44 1454 616777

**Distributed By:**



# SlimSlatz

## Low Profile Interior Directory System



Elegant directories  
 Refined signs  
 Attractive profiles  
 Architectural appeal

### The SlimSlatz system combines versatility and elegance.

This refined sign system offers the same attractive user benefits as the original Slatz concept. Spandex designers have condensed the Slatz virtues of simplicity, versatility, and functionality into an assembled profile of less than 8mm - though nothing has been sacrificed in terms of appearance. Every SlimSlatz component has been designed with elegance in mind. Top and bottom faceplates fit flush to the mounting surface. This conceals the inner workings of the directory and provides a perfect finish to a perfect sign system.

SlimSlatz co-ordinates beautifully with every other system in the Spandex range. Which means that even the smallest interior sign can complement the largest exterior identity programme.

# Spandex Modular Sign Systems

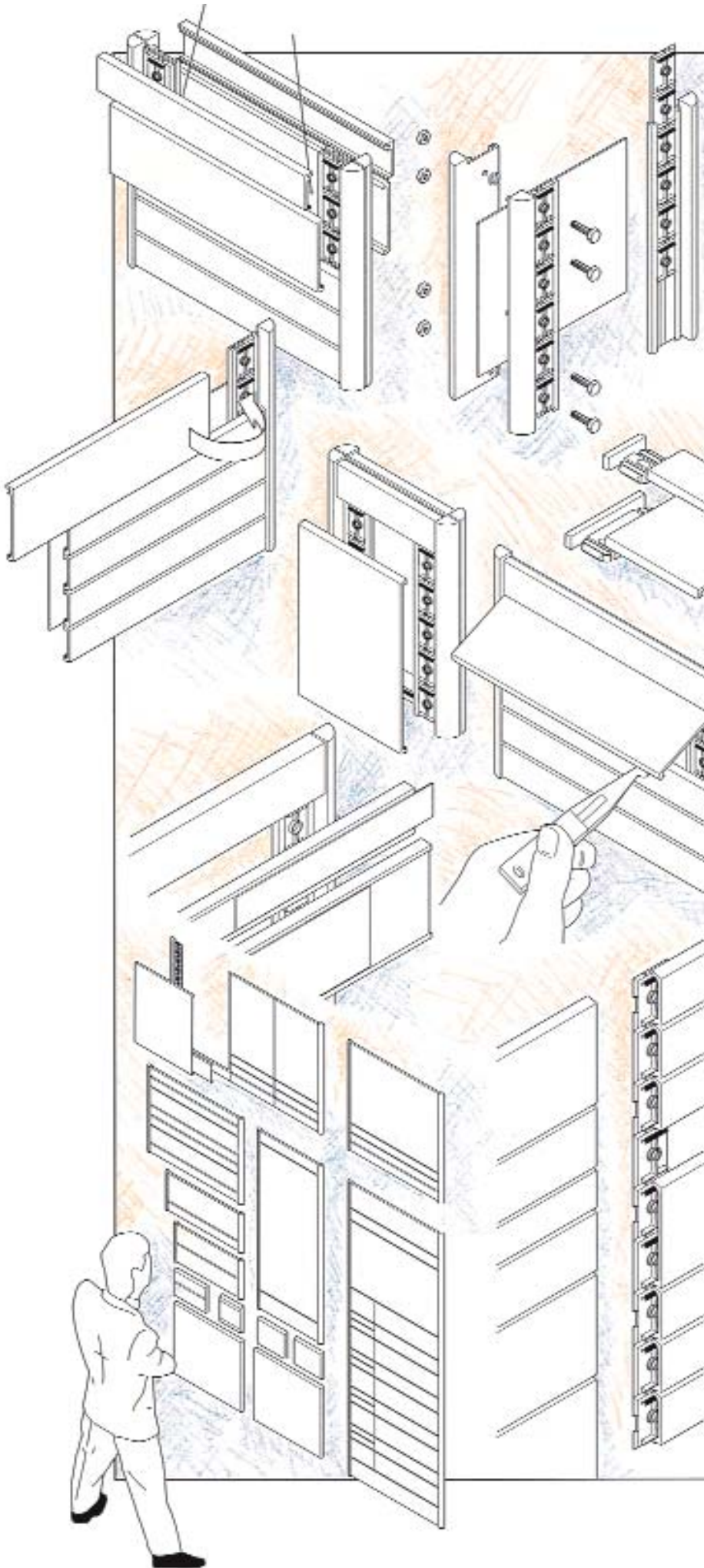

**AUSTRIA**

**Spandex GmbH**  
 Tel 00 43 1769 3950  
 Fax 00 43 1769 3966

**BELGIUM**

**Spandex Benelux NV SA**  
 Tel 00 32 2725 7370  
 Fax 00 32 2720 7640

**CANADA**

**ND Graphic Products Ltd**  
 Tel 001 416 663 6416  
 Fax 001 416 663 5629

**CZECH REPUBLIC**

**Spandex Syndicut Sro**  
 Tel 00 420 286 006455  
 Fax 00 420 286 006400

**FRANCE**

**Spandex France SA**  
 Tel 00 33 169 352 450  
 Fax 00 33 169 352 499

**GERMANY**

**H. Brunner GmbH**  
 Tel 00 49 7841 685 200  
 Fax 00 49 7841 685 100

**HOLLAND**

**Spandex Benelux BV**  
 Tel 00 31 318 530 111  
 Fax 00 31 318 527 960

**ITALY**

**Spandex Srl**  
 Tel 00 39 0332 420 611  
 Fax 00 39 0332 420 620

**SLOVAKIA**

**Spandex Unifol Sro**  
 Tel 00 4212 5720 5555  
 Fax 00 4212 5720 5500

**SPAIN**

**Spandex Espana SA**  
 Tel 00 34 93 656 9040  
 Fax 00 34 93 656 9041

**SVERIGE**

**R&D Sverige AB**  
 Tel 00 46 430 738 29  
 Fax 00 46 430 133 17

**SWITZERLAND**

**Spandex AG**  
 Tel 00 41 1818 8686  
 Fax 00 41 1818 8688

**UNITED KINGDOM**

**Spandex Ltd**  
 Tel 00 44 1454 616444  
 Fax 00 44 1454 616777

**Distributed By:**



# Spandex Modular Sign Systems

**AUSTRALIA**

**Gravograph Australia**  
Tel +61 296842400  
Fax +61 296842500

**AUSTRIA**

**Spandex Ges.mbH**  
Tel +43 17693950  
Fax +43 17693966

**BELGIE/BELGIQUE**

**Spandex Benelux NVSA**  
Tel +32 27257370  
Fax +32 27207640

**CANADA**

**ND Graphic Products Ltd**  
Tel +41 66636416  
Fax +41 66635629

**ČESKA REPUBLIKA**

**Spandex SyndiCut s.r.o.**  
Tel +42 0286006455  
Fax +42 0286006400

**CHINA**

**Sign Supplies Centre Ltd**  
Tel +852 55550451  
Fax +852 28108708  
**Hangson Syn**  
Tel +852 27456186  
Fax +852 27862355

**CYPRUS**

**G H Yacoubian Limited**  
Tel +35 72678393  
Fax +35 72669009

**DENMARK**

**Dansk Skilte Import**  
Tel +45 44927304  
Fax +45 44927303

**DEUTSCHLAND**

**H Brunner GmbH**  
Tel +49 7841685200  
Fax +49 7841685100

**EIRE**

**Trimwel Limited**  
Tel +35 312940188  
Fax +35 312940190

**ESPAÑA**

**Spandex España SA**  
Tel +93 6569040  
Fax +93 6569041

**FRANCE**

**Spandex France SA**  
Tel +33 169352450  
Fax +33 169352499

**GREECE**

**Daltec SA**  
Tel +30 2106640511  
Fax +30 2106640516

**ICELAND**

**Merking Limited**  
Tel +354 5627044  
Fax +354 5626787



**ISRAEL**

**Kadouri Industrial Design Limited**  
Tel +972 89276333  
Fax +972 89276366

**ITALIA**

**Spandex Srl**  
Tel +39 0332420611  
Fax +39 0332420620

**NETHERLAND**

**Spandex Benelux BV**  
Tel +31 318530111  
Fax +31 318527960

**NEW ZEALAND**

**Deneefe Ltd**  
Tel +64 02328252  
Fax +64 02325306

**NORWAY**

**Alvoen AS**  
Tel +47 55506630  
Fax +47 55506640

**RUSSIA**

**Sventa AG**  
Tel +7 0952554858  
Fax +7 0952554855

**SINGAPORE**

**Gravograph Singapore Pte Ltd**  
Tel +65 4722100  
Fax +65 4727100

**SLOVENSKO**

**Spandex Unifol sro**  
Tel +42 17362717  
Fax +42 17364632

**SOUTH AFRICA**

**Statmark (Pty) Limited**  
Tel +27 116204600  
Fax +27 116204690

**SUISSE/SCHWEIZ**

**Spandex AG**  
Tel +41 18188686  
Fax +41 18188688

**SVERIGE**

**R&D Sverige AB**  
Tel +46 43073800  
Fax +46 43013317

**UNITED ARAB EMIRATES**

**Masonlite Sign Supplies & Equipment**  
Tel +971 4694549  
Fax +971 4687020

**UNITED STATES**

**Clarke Systems Inc**  
Tel +1 8003311891  
Fax +1 6104349868

**UNITED KINGDOM**

**Spandex Ltd**  
Tel +44 800772633  
Fax +44 800373936

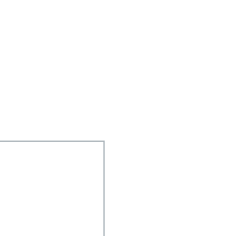
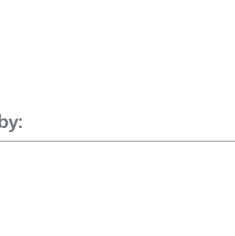

Distributed by:

